

MIDNIGHT SINGLE VARIO Ø 60 CM

Pendelleuchte | hanging lamp | suspension | luce a sospensione

Lieferumfang:

Scope of supply:

contenu de la livraison:

consegna:



1x



1

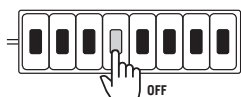

2

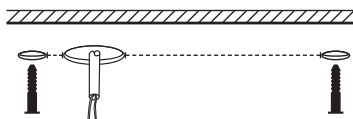

3

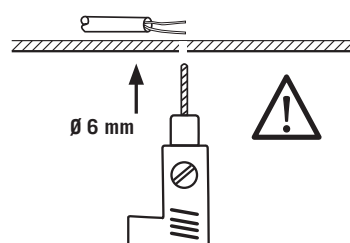

Ø 6 mm



4

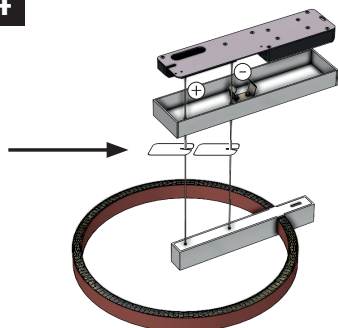

5

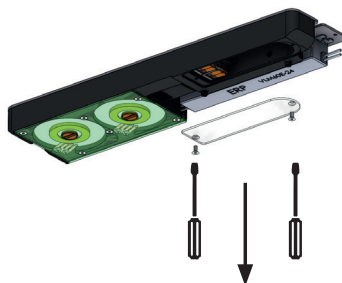

6

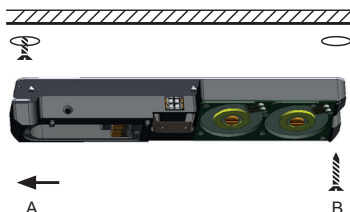

A

B

7

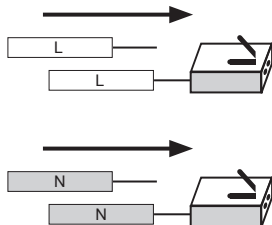

8

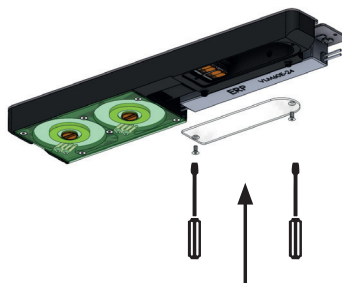

9

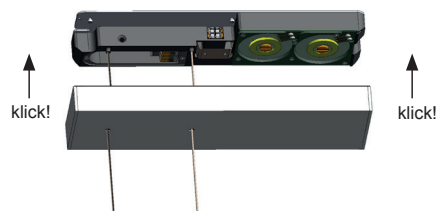

klick!

klick!

BEI BEDARF / AS NEEDED:

10

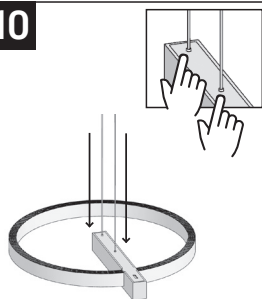

11

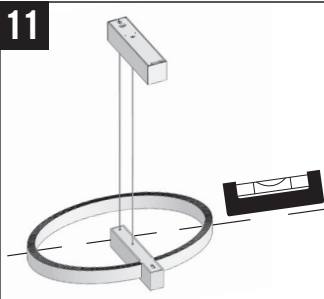

12



13



LIEFERZUSTAND
DELIVERY CONDITION:
FIX: 0,50 m (> Pos. 10)

VARIO: 1,10 m

MAX: 1,60 m

Technische Angaben / technical data / specifications techniques / specifiche tecniche

08.2023

Art. Nr.: 882 913 00 / 884 913 00 / 885 913 00 / 904 913 00

886 913 00 / 889 913 00 / 890 913 00 / 905 913 00

893 913 00 / 895 913 00 / 896 913 00 / 906 913 00

230V - 50Hz; LED-Band 24V; 35W - 3.400 lm @ 2.000 K; 25W - 3.750 lm @ 5.000 K; Ra90



11 bei Bedarf / as needed:

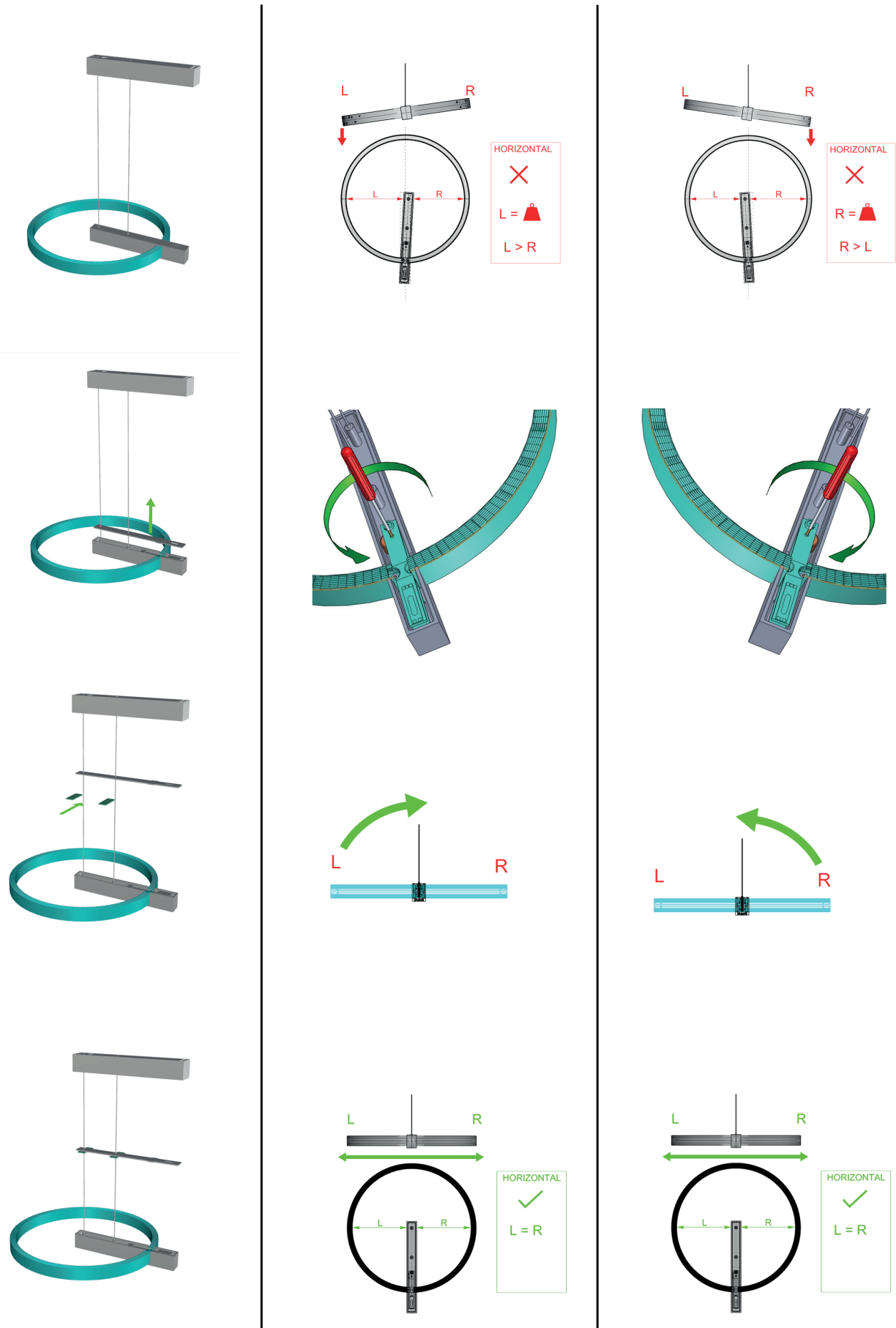

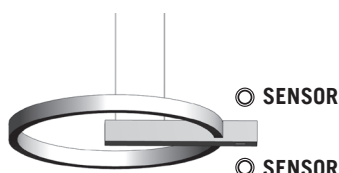
01

FUNKTIONEN

Die Pendelleuchten der Serie MIDNIGHT sind mit 2 Sensoren ausgestattet, über die Sie die Leuchte (ein-/aus-)schalten, dimmen und die Farbtemperatur anpassen können.

Diese befinden sich jeweils an der Ober- und Unterseite der Leuchte. Das Ober- und Unterlicht des Rings lässt sich dadurch einzeln und individuell einstellen.

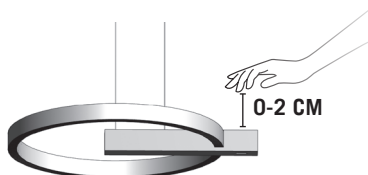
02

EINSCHALTEN

Mit einer einfachen Wischbewegung am Sensor schalten Sie die jeweilige Seite der Leuchte ein.

Danach befindet man sich **grundsätzlich im Dimmmodus**.

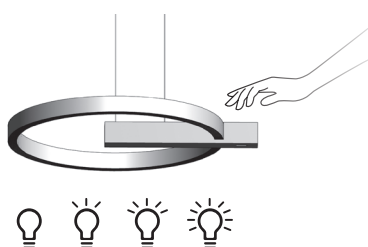
03

DIMMEN

Die Leuchte startet **immer** mit dem **Dimmmodus**:

Halten Sie die Hand länger über den Sensor, so lässt sich die Leuchte dimmen. Bleibt die Hand am Sensor und der Dimmmodus hat eine Helligkeit von 100% erreicht, blinkt die Leuchte 1x zur Bestätigung der maximalen Helligkeit. Entfernen Sie die Hand zuvor kurz vom Sensor und greifen dann wieder ein, kann die Dimmrichtung gewechselt werden (hell >> dunkel; dunkel >> hell).

Nachdem Sie die gewünschte Helligkeit eingestellt haben, entfernen Sie die Hand vom Sensor. **Die Leuchte blinkt 2x zur Bestätigung des Dimmmodus**.

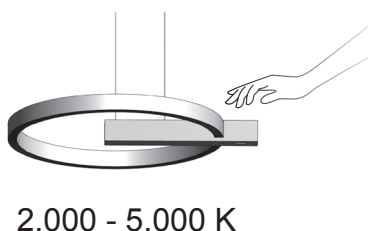
04

FARBSTEUERUNG

Zum Wechsel in die Funktion Farbsteuerung:

Um in den Farbmodus zu gelangen, starten Sie im Dimmmodus und unterbrechen Sie die Bestätigung nach dem 1. Blinken.

Jetzt können Sie Ihre individuelle Farbtemperatur einstellen.

Halten Sie die Hand länger über den Sensor, so lässt sich die Farbtemperatur der Leuchte von 2.000 Kelvin (warmweiß) bis 5.000 Kelvin (kaltweiß) einstellen. Ein kurzes Absetzen der Handbewegung führt zu einem Richtungswechsel der Farbsteuerung von warmem nach kaltem Licht und umgekehrt.

Die Leuchte blinkt zur Bestätigung und Speicherung der Einstellungen 1x. >> Danach wechselt die Bedienung wieder in die Funktion „dimmen“!

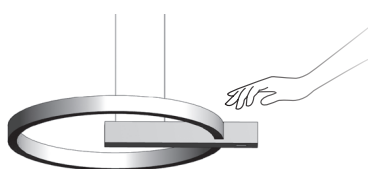
05

AUSSCHALTEN

Die Leuchte verfügt über eine eingebaute Memory-Funktion: so werden Ihre individuell gewählten Einstellungen nach dem Ausschalten beibehalten.

Mit einer einfachen Wischbewegung am Sensor schalten Sie die jeweilige Seite der Leuchte aus.

06

VIDEO

Ein Video zur Bedienung der Gestensteuerung finden Sie hier:

>> you tube, Escale, Midnight, Gestensteuerung

GESTURE CONTROL E	CONTRÔLE PAR GESTES F	CONTROLLO GESTUALE IT
<p>01</p> <p>FUNCTIONS</p> <p>The hanging lamps in the MIDNIGHT series are equipped with 2 sensors with which you can switch the lamp on/off, dim the lamp, and adjust the color temperature.</p> <p>There is one sensor located on the top and one on the bottom of the lamp. The uplight and downlight of the ring can be adjusted individually.</p>	<p>FONCTIONS</p> <p>Les luminaires suspendus de la série MIDNIGHT sont équipés de 2 capteurs pouvant être utilisés pour allumer ou éteindre la lumière, la faire varier et régler la température de couleur.</p> <p>Ceux-ci se trouvent en haut et en bas de la lampe. Les lumières supérieure et inférieure de l'anneau peuvent ainsi être réglées séparément.</p>	<p>FUNZIONI</p> <p>Le lampade a sospensione della serie MIDNIGHT sono dotate di 2 sensori per accendere e spegnere la luce (on/off), regolare la luminosità e la temperatura del colore. Gli stessi si trovano nella parte superiore e inferiore della lampada.</p> <p>La luce superiore e inferiore dell'anello può quindi essere regolata separatamente e in maniera individuale.</p>
<p>02</p> <p>SWITCHING ON</p> <p>A simple wiping gesture near the sensor will switch the corresponding side of the lamp on.</p> <p>The lamp is always in the dimming mode after switching on.</p>	<p>ALLUMER</p> <p>D'un simple passage de main devant le capteur, vous allumez le côté correspondant de la lumière.</p> <p>Ensuite, vous êtes essentiellement en mode de variation de lumière.</p>	<p>ACCENSIONE</p> <p>Con un semplice movimento touch sul sensore, è possibile accendere il rispettivo lato della lampada.</p> <p>Dopo l'accensione, la lampada si trova sempre nella modalità di regolazione della luminosità.</p>
<p>03</p> <p>DIMMING</p> <p>The lamp always starts in the dimming mode: Holding your hand for a longer time over the sensor dims the lamp.</p> <p>If your hand remains over the sensor and the lamp has reached a brightness of 100% in the dimming mode, then the lamp flashes 1x to confirm the maximum brightness. If you remove your hand from the sensor shortly before reaching 100% and then place it over the sensor again, you can reverse the dimming direction (bright >> dark; dark >> bright).</p> <p>Once you have reached the desired brightness, remove your hand from the sensor. The lamp flashes 2x to confirm the dimming mode.</p>	<p>VARIATION DE LUMIÈRE</p> <p>La lampe s'allume toujours en mode de variation de lumière :</p> <p>Si vous tenez votre main au-dessus du capteur plus longtemps, l'intensité de lumière peut être modifiée. Si vous tenez votre main au-dessus du capteur et que le mode de variation a atteint une luminosité de 100 %, la lampe clignote une fois pour confirmer la luminosité maximale. Si vous retirez d'abord brièvement votre main du capteur, puis que vous l'approchez à nouveau, vous pouvez changer le sens de la variation (clair >> sombre ; sombre >> clair).</p> <p>Une fois que vous avez réglé la luminosité souhaitée, éloignez votre main du capteur. La lumière clignote 2x pour confirmer le mode de variation.</p>	<p>REGOLAZIONE DELLA LUMINOSITÀ</p> <p>La lampada si accende sempre nella modalità di regolazione della luminosità: Mantieni la mano più a lungo sopra il sensore per regolare la luminosità della lampada. Se mantieni la mano sul sensore e la luminosità raggiunge il 100% della potenza, la lampada lampeggia una volta per confermare il massimo livello raggiunto. Se allontani e riavvicini la mano al sensore, la direzione di regolazione si inverte (chiaro >> scuro; scuro >> chiaro).</p> <p>Dopo aver impostato la luminosità desiderata, allontana la mano dal sensore. La luce lampeggia due volte per confermare la modalità di regolazione della luminosità.</p>
<p>04</p> <p>CHANGING COLORS</p> <p>Switching to the color control function: To switch to the color mode, start in the dimming mode and then interrupt confirmation after the lamp flashes the 1st time.</p> <p>Now you can set the color to the desired color temperature.</p> <p>If you hold your hand longer over the sensor, then you can adjust the color temperature of the lamp from 2,000 Kelvin (warm white) to 5,000 Kelvin (cool white). Briefly removing your hand causes the color control to switch directions from warm to cool light and vice-versa.</p> <p>The lamp flashes 1x to confirm and save the settings. >> The lamp then switches back to the dimming mode!</p>	<p>CONTRÔLE DES COULEURS</p> <p>Pour passer à la fonction de contrôle des couleurs : Pour passer en mode couleur, démarrez en mode variateur et interrompez la confirmation après le 1er clignotement.</p> <p>Vous pouvez maintenant régler votre température de couleur individuelle.</p> <p>Si vous maintenez votre main devant le capteur pendant un certain temps, la température de couleur de la lampe peut être ajustée de 2 000 Kelvin (blanc chaud) à 5 000 Kelvin (blanc froid). Un court arrêt du mouvement de la main entraîne un changement de direction du contrôle de la couleur, de la lumière chaude à la lumière froide et inversement.</p> <p>La lumière clignote 1x pour confirmer et enregistrer les réglages. >> Ensuite, le contrôle revient à la fonction « variation de lumière » !</p>	<p>REGOLAZIONE DEL COLORE</p> <p>Per passare alla funzione di regolazione del colore: Per entrare nella modalità di regolazione del colore, accendere la lampada nella modalità di regolazione della luminosità, quindi interrompere la conferma dopo il primo flash.</p> <p>Adesso è possibile impostare la temperatura di colore che si preferisce.</p> <p>Mantenendo la mano vicino al sensore per un tempo prolungato, la temperatura del colore della lampada passa da 2.000 Kelvin (bianco caldo) a 5.000 Kelvin (bianco freddo). Un breve allontanamento della mano porta ad un cambio di direzione della regolazione del colore da luce calda a luce fredda e viceversa.</p> <p>La luce lampeggia una volta per confermare e salvare le impostazioni. >> Alla fine di questa procedura, la lampada ritorna nella modalità „Regolazione della luminosità“!</p>
<p>05</p> <p>SWITCHING OFF</p> <p>The lamp has a built-in memory function: the settings you have selected will be retained after switching off the lamp.</p> <p>A simple wiping gesture near the sensor will switch the corresponding side of the lamp off.</p>	<p>ÉTEINDRE</p> <p>La lampe possède une fonction mémoire intégrée : cela signifie que les réglages choisis individuellement sont conservés lorsqu'elle est éteinte.</p> <p>D'un simple passage de main devant le capteur, vous éteignez le côté correspondant de la lumière.</p>	<p>SPEGNIMENTO</p> <p>La lampada è dotata di una funzione di memoria integrata: ciò significa che le impostazioni scelte individualmente vengono mantenute anche dopo lo spegnimento.</p> <p>Con un semplice movimento touch sul sensore, è possibile spegnere il rispettivo lato della lampada.</p>
<p>06</p> <p>VIDEO</p> <p>You will find a video on the how to operate the gesture control here: >> YouTube, Escale, Midnight, gesture control</p> 	<p>VIDÉO</p> <p>Vous pouvez trouver une vidéo sur le fonctionnement du contrôle par gestes ici : >> youtube, Escale, Midnight, contrôle par gestes</p> 	<p>VIDEO</p> <p>Qui è possibile guardare un video sul funzionamento del controllo gestuale: >> youtube, Escale, Midnight, controllo gestuale</p> 